



# Res

Italia 20038 Seregno (Mi)  
 Via Cassina Savina, 49  
 tel: +39 0362 238620  
 fax: +39 0362 327860  
 e-mail: info@resitalia.it  
 www.resitalia.it

Date \_\_\_\_\_  
 Customer \_\_\_\_\_  
 Town \_\_\_\_\_  
 Ref. \_\_\_\_\_

### Sent by

Name \_\_\_\_\_  
 Tel \_\_\_\_\_  
 Fax \_\_\_\_\_  
 E-mail \_\_\_\_\_  
 Availability from \_\_\_\_\_

### Delivery

Usual place  
 Ex - works  
 Different place from usual \_\_\_\_\_  
 Requested date \_\_\_\_\_  
 \_\_\_\_\_

## WING DOORS WITH EXTERNAL DOOR JAMB

### Product

- Miss       Levia  
 Luna       Arc  
 Dorsia  
 Mood XL  
 \_\_\_\_\_

### Typology and dimensions

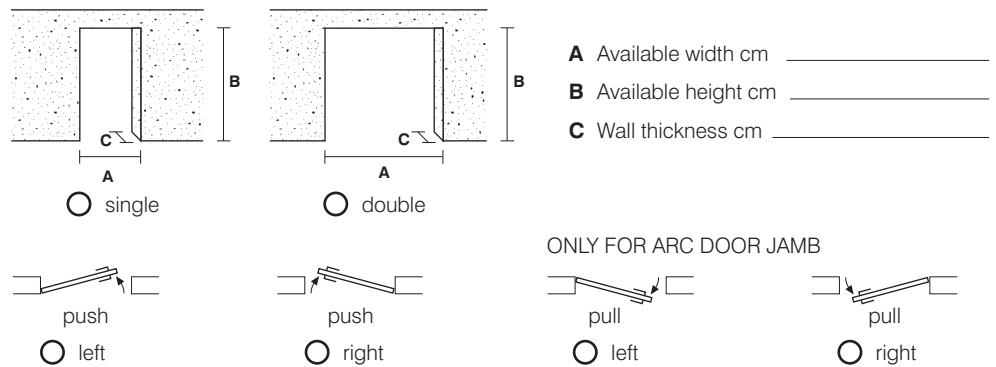

### Panel **YES NO**

Quantity n° \_\_\_\_\_  
 Glass finishing\* \_\_\_\_\_  
 Glass finishing \_\_\_\_\_ + Lacquered panel finishing \_\_\_\_\_  
 Wood finishing \_\_\_\_\_  
 Lacquered finishing \_\_\_\_\_

Client glass **YES NO**  
 Client panel **YES NO**  
 One finishing **YES NO**  
 More finishing **YES NO** (show it on the drawing)

\* We supply the glass with the glossy side in the front and the mat side on the back. We can change them if you specify it when placing your order.

### Frame **YES NO** (no Miss)

Quantity n° \_\_\_\_\_  
 Finishing \_\_\_\_\_

### Door jamb **YES NO**

Quantity n° \_\_\_\_\_ Finishing \_\_\_\_\_  
 Type of door jamb:  
 Standard (Miss, Luna, Dorsia, Mood XL)       Arc without insert  
 Decò (Miss, Levia) - Only push opening       Arc with insert - Insert has the same finishing of the door

### Handles **YES NO**

Code \_\_\_\_\_ Finishing \_\_\_\_\_

### Locks **YES NO**

Code \_\_\_\_\_ Finishing \_\_\_\_\_  
 customer's handle       customer's lock       model \_\_\_\_\_





# Res

Italia 20038 Seregno (Mi)  
 Via Cassina Savina, 49  
 tel: +39 0362 238620  
 fax: +39 0362 327860  
 e-mail: info@resitalia.it  
 www.resitalia.it

Date \_\_\_\_\_  
 Customer \_\_\_\_\_  
 Town \_\_\_\_\_  
 Ref. \_\_\_\_\_

### Sent by

Name \_\_\_\_\_  
 Tel \_\_\_\_\_  
 Fax \_\_\_\_\_  
 E-mail \_\_\_\_\_  
 Availability from \_\_\_\_\_

### Delivery

Usual place  
 Ex - works  
 Different place from usual \_\_\_\_\_  
 Requested date \_\_\_\_\_  
 \_\_\_\_\_

## WING DOORS WITH BUILT-IN DOOR JAMB

### Product

Levia       4.1 (only flush with the ceiling)       Wave       Miss       Decò

### Typology

Brick wall       Plaster wall

### Door jamb YES NO

NOTE: 4.1 DOOR CAN'T BE REDUCED IN WIDTH

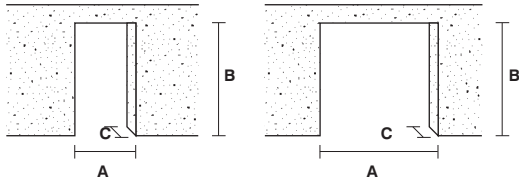

single       double

**A** Available width cm \_\_\_\_\_  
**B** Available height cm \_\_\_\_\_  
**C** Wall thickness cm \_\_\_\_\_

#### For door:

left to push n° \_\_\_\_\_  
 right to push n° \_\_\_\_\_  
 left to pull n° \_\_\_\_\_  
 destra a tirare n° \_\_\_\_\_

### Door YES NO

NOTE: 4.1 DOOR CAN'T BE REDUCED IN WIDTH

Once one of the door jamb is fitted into the wall and floor is down, supply us with the following (see the drawing):

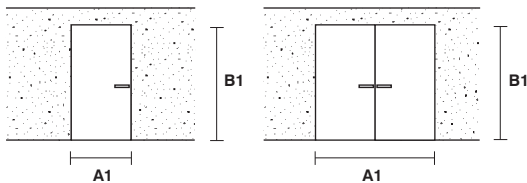

single       double

**A1** Internal door jamb width cm \_\_\_\_\_  
**B1** Internal door jamb height cm \_\_\_\_\_

#### Door:

left to push n° \_\_\_\_\_  
 finishing \_\_\_\_\_  
 right to push n° \_\_\_\_\_  
 finishing \_\_\_\_\_  
 left to pull n° \_\_\_\_\_  
 finishing \_\_\_\_\_  
 right to pull n° \_\_\_\_\_  
 finishing \_\_\_\_\_

### Reference order of the door jamb already delivered

### Handles YES NO

Code \_\_\_\_\_ Finishing \_\_\_\_\_

### Locks YES NO

Code \_\_\_\_\_ Finishing \_\_\_\_\_

customer's handle       customer's lock       model \_\_\_\_\_

# TAKING RIGHT DIMENSION WITH BUILT-IN JAMB

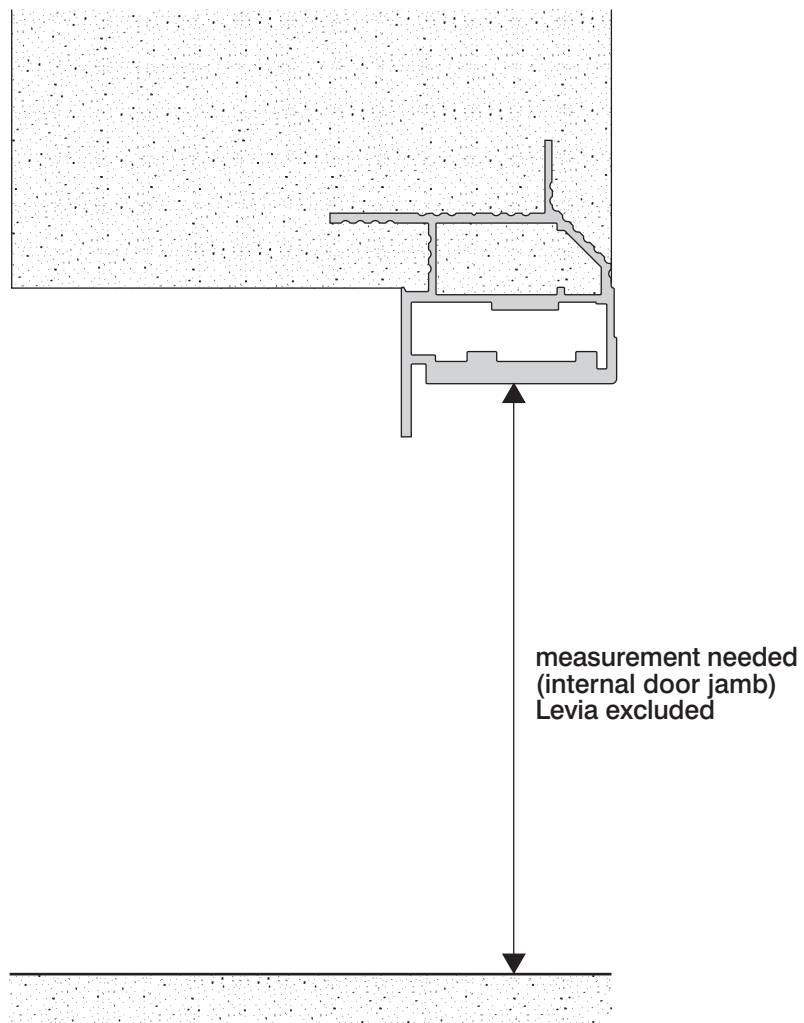
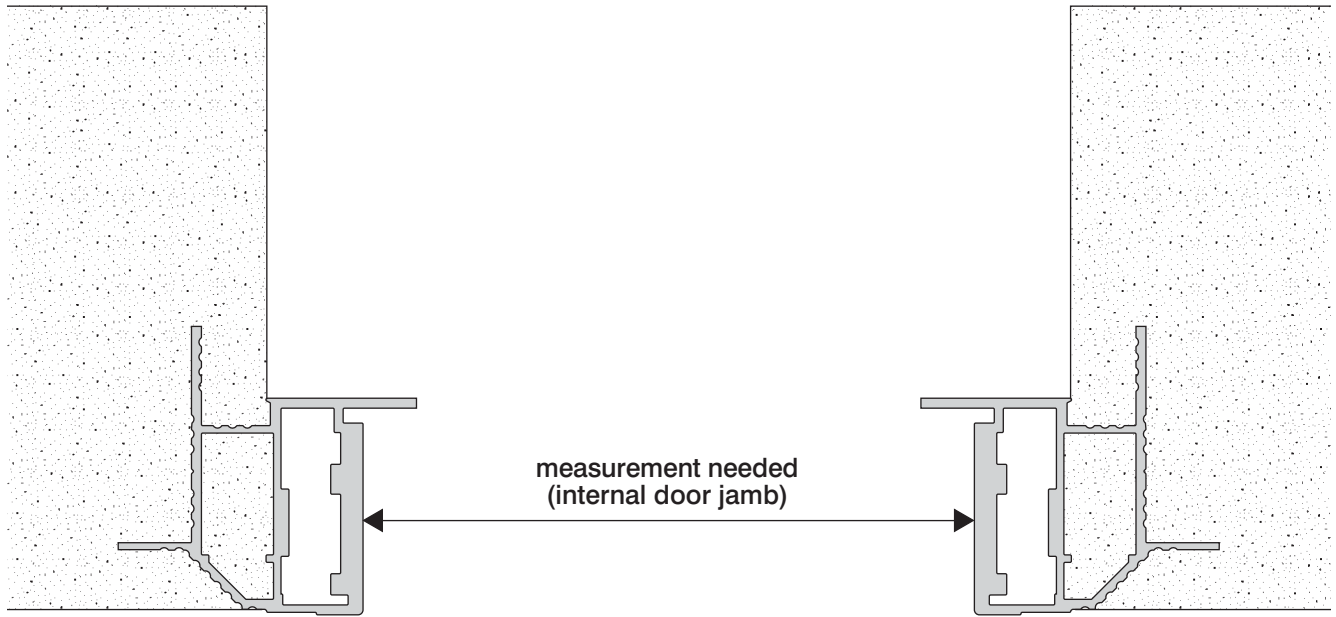

# POSITION OF LOCK AND HINGES FOR BUILT-IN JAMB

\* dimension to be taken

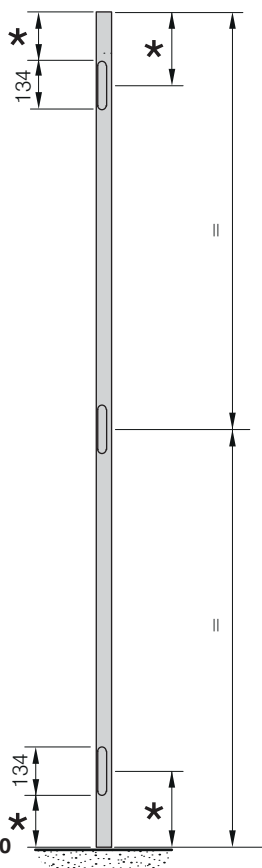
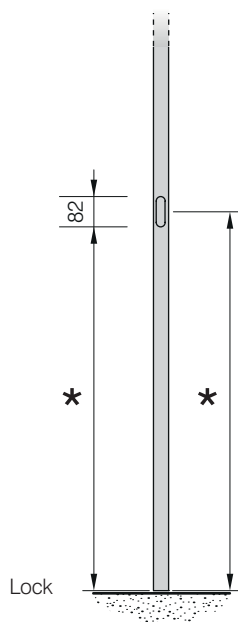

Jamb with 3 hinges up to h. 2300

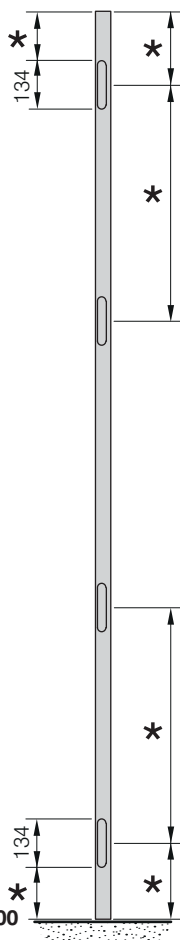

Jamb with 4 hinges up to h. 2500

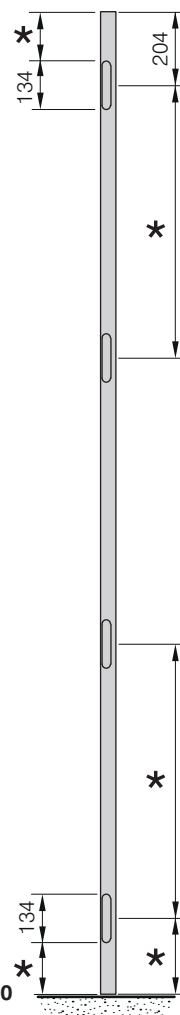

Jamb with 4 hinges up to h. 3000

# POSITION OF LOCK AND HINGES FOR BUILT-IN JAMB FLUSH WITH THE CEILING

\* dimension to be taken

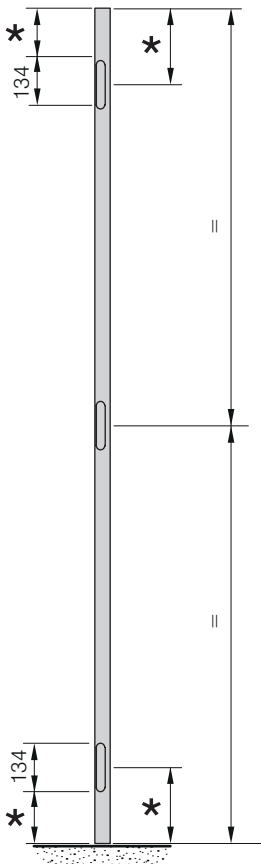
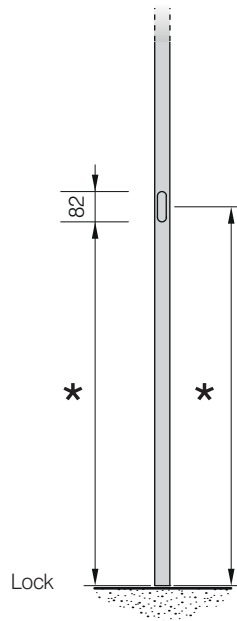

Jamb with 3 hinges flush with the ceiling version up to h. 2300

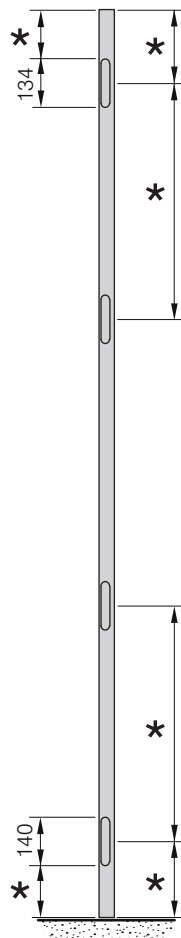

Jamb with 4 hinges flush with the ceiling version up to h. 2500

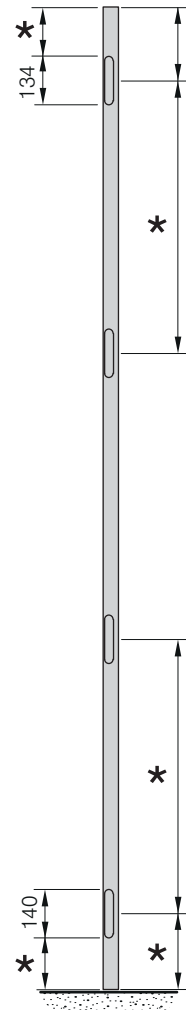

Jamb with 4 hinges flush with the ceiling version up to h. 3000



# Res

Italia 20038 Seregno (Mi)  
 Via Cassina Savina, 49  
 tel: +39 0362 238620  
 fax: +39 0362 327860  
 e-mail: info@resitalia.it  
 www.resitalia.it

Date \_\_\_\_\_  
 Customer \_\_\_\_\_  
 Town \_\_\_\_\_  
 Ref. \_\_\_\_\_

### Sent by

Name \_\_\_\_\_  
 Tel \_\_\_\_\_  
 Fax \_\_\_\_\_  
 E-mail \_\_\_\_\_  
 Availability from \_\_\_\_\_

### Delivery

Usual place  
 Ex - works  
 Different place from usual \_\_\_\_\_  
 Requested date \_\_\_\_\_  
 \_\_\_\_\_

## WING DOORS WITH TIRA SPINGI DOOR JAMB

### Product

- Dorsia monodirezionale       Dorsia bidirezionale  
 Miss monodirezionale       Miss bidirezionale  
 Levia monodirezionale       Levia bidirezionale

### Opening



### Dimensions

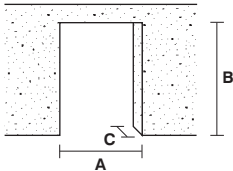

A Available width cm \_\_\_\_\_  
 B Available height cm \_\_\_\_\_  
 C Wall thickness cm \_\_\_\_\_

Once of the door jamb is fitted into the wall and floor is down, supply us with the following:

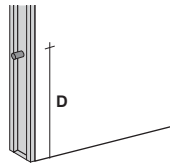
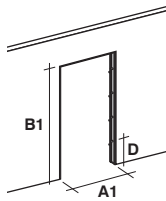

A1 Internal door jamb width cm \_\_\_\_\_  
 B1 Internal door jamb height cm \_\_\_\_\_  
 D Height of the pin cm \_\_\_\_\_

### Door jamb YES NO

- Door jamb with cover jambs n° \_\_\_\_\_ finishing \_\_\_\_\_  
 Built-in door jamb for brick wall n° \_\_\_\_\_  
 Built-in door jamb for plaster wall n° \_\_\_\_\_

### Door frame YES NO

Quantity n° \_\_\_\_\_  
 Finishing \_\_\_\_\_  
 \_\_\_\_\_

### Panel YES NO

- Quantity n° \_\_\_\_\_  
 Glass finishing\* \_\_\_\_\_  
 Glass finishing \_\_\_\_\_ + Lacquered panel finishing \_\_\_\_\_  
 Wood finishing \_\_\_\_\_  
 Lacquered finishing \_\_\_\_\_

Client glass **YES NO**  
 Client panel **YES NO**  
 One finishing **YES NO**  
 More finishing **YES NO** (show it on the drawing)

\* We supply the glass with the glossy side in the front and the mat side on the back. We can change them if you specify it when placing your order (Dorsia only).

### Handles YES NO

Code \_\_\_\_\_ Finishing \_\_\_\_\_

### Locks YES NO

Code \_\_\_\_\_ Finishing \_\_\_\_\_

- customer's handle       customer's lock       model \_\_\_\_\_







# Res

Italia 20038 Seregno (Mi)  
 Via Cassina Savina, 49  
 tel: +39 0362 238620  
 fax: +39 0362 327860  
 e-mail: info@resitalia.it  
 www.resitalia.it

Date \_\_\_\_\_  
 Customer \_\_\_\_\_  
 Town \_\_\_\_\_  
 Ref. \_\_\_\_\_

### Sent by

Name \_\_\_\_\_  
 Tel \_\_\_\_\_  
 Fax \_\_\_\_\_  
 E-mail \_\_\_\_\_  
 Availability from \_\_\_\_\_

### Delivery

Usual place  
 Ex - works  
 Different place from usual \_\_\_\_\_  
 Requested date \_\_\_\_\_  
 \_\_\_\_\_

## 10.8 WING DOORS

### Tipology

Brick wall       Plaster wall

### Version

Curved       Straight

### Door jamb **YES NO**

NOTE: 10.8 DOOR CAN'T BE REDUCED IN WIDTH

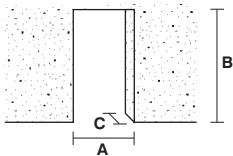

A Available width cm \_\_\_\_\_

For door:

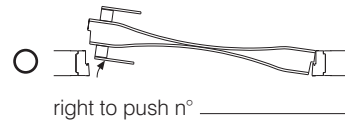
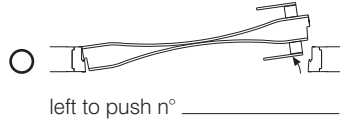

B Available height cm \_\_\_\_\_

C Brick wall/Plaster wall thickness cm \_\_\_\_\_

### Door **YES NO**

NOTE: 10.8 DOOR CAN'T BE REDUCED IN WIDTH

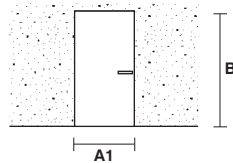

A1 External door jamb width cm \_\_\_\_\_  
 built-in door jamb

Door:

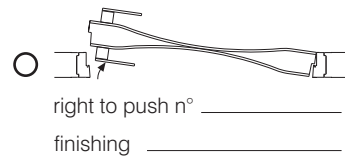
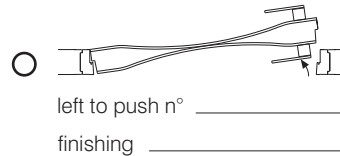

B Available height cm \_\_\_\_\_

Reference order of the door jamb already delivered \_\_\_\_\_

### Built-in door jamb detail

NOTE: 10.8 DOOR CAN'T BE REDUCED IN WIDTH

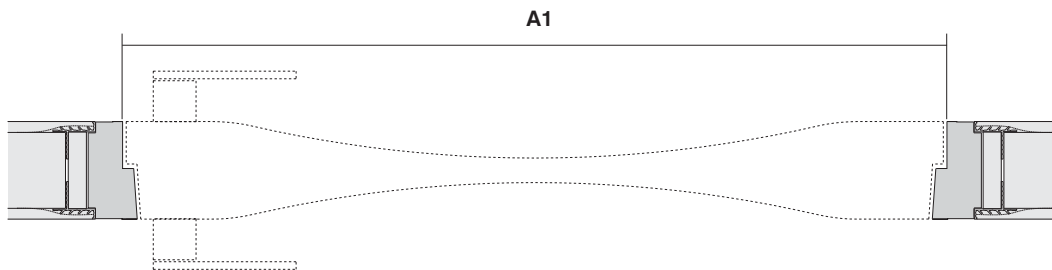

### Handles **YES NO**

Code \_\_\_\_\_ Finishing \_\_\_\_\_

### Locks **YES NO**

Code \_\_\_\_\_ Finishing \_\_\_\_\_

customer's handle       customer's lock       model \_\_\_\_\_

